

FCST012216 Fiber Optical Splice Closure



Product Overview

FCST012216 Fiber Optical Splice Closure is used to connect the distribution cable and the incoming cable, is widely applied in communication, network systems, CATV cable TV and so on. It adopts scientifically formulated engineering plastic and be shaped by injection molding, with anti-aging, anti-corrosion, flame retardant, waterproof, anti-vibration and anti-shock effects. Can effectively prevent the optic fibers from the influence of outdoor environment. Dome-to-base design; sealed with clamp and O-ring system. With two types of optional trays can hinge for access of any splice, without disturbing others trays; Fast and reliable sealing performance, easy to package multiple times. With lightning protection grounding device, it can be applied in overhead, pole/ wall mounting or directly buried.

Product Specifications

| Construction | Description | |
|----------------------|---|---|
| Model | FCST012216(GP220) | FCST012216(GP304) |
| Size | 504*298 mm | 504*298 mm |
| Entry Ports Number | 1 oval port, 8 middle size round ports, 8 small size round ports | 1 oval port, 6 round ports |
| Max. Tray Number | 24pcs | 24pcs |
| Tray Capacity | RQP-15-12c: 12F/tray RQP-26-4c: 4F/tray | RQP-15-12c: 12F/tray RQP-26-4c: 4F/tray |
| Max.Capacity | 288F (if with 12F tray, total 24 pcs) 192F (if with 4F tray, total 48 pcs) | 288F (if with 12F tray, total 24 pcs) 192F (if with 4F tray, total 48 pcs) |
| Available Cable Dia. | 1 oval port for 2 pcs 10~30mm cable 8 middle round ports each for 1 pc 6~21mm cable 8 small round ports each for 1 pc 6-16mm cable. | 1 oval port for 2 pcs 10~30mm cable 6 round ports each for 1 pc 6~ 33mm cable |

FCST012216 Fiber Optical Splice Closure





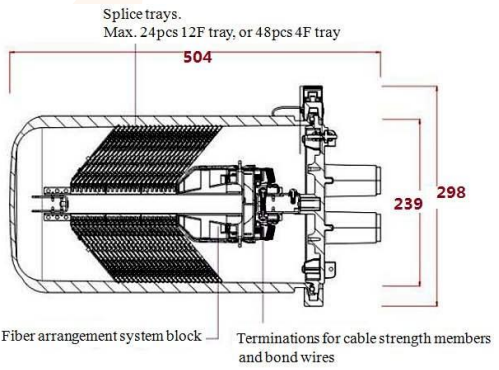
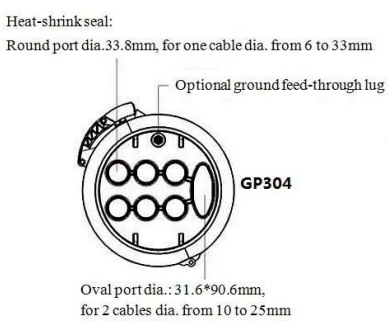
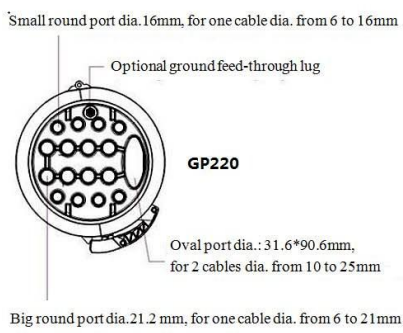













| | |
|-----------------------|---|
| Raw Material | Dome, clamp, base: modified PP +GF Tray: ABS Metal parts: Stainless steel |
| Base Sealing Method | Heat-shrink |
| Applications | Aerial, Pole mounting, directly buried, Wall mounting |
| Protection Level | IP68 |
| Working Temperature | -40 degrees centigrade~+65 degrees centigrade |
| Atmospheric Pressure | 62~106Kpa |
| Axial Tension | >1000N/1min |
| Flatten Resistance | 2000N/100 mm (1min) |
| Insulation Resistance | >2*104MΩ |
| Voltage Strength | 15KV(DC)/1min, no arc over or breakdown |
| Temperature Recycle | under -40°C~+65°C, with 60(+5)Kpa inner pressure, in 10cycles; Inner pressure shall decrease less than 5 Kpa when closure turn to normal temperature. |
| Durability | 25 years |

Product Structure



FCST012216 Fiber Optical Splice Closure

Main Components

| No. | Name | Qty | Picture | No. | Name | Qty | Picture |
|-----|--------------------------------------|---------------------------|---|-----|-------------------------------|---------------------------|---|
| 1 | Dome | 1pc |  | 2 | Tray | Max.48pc (RQP-26-4c) |  |
| | | | | | | Max. 24pc (RQP-15-12c) |  |
| 3 | Clamp | 1pc |  | 4 | Valve | 1pc (Optional) |  |
| 5 | Base | 1pc(GP220) |  | 6 | Modified O-ring | 1pc |  |
| | | 1pc(GP304) |  | | | | |
| 7 | Cable Strengthen member attach plate | 1set |  | 8 | Velcro strip with one X flake | 2pc |  |
| 9 | optic joints protection tube | Max. 288pc |  | 10 | Ground feed-through lug | 1pc (Optional) |  |
| 11 | Nylon tie | Max. 1 bag (12pcs/bag) |  | 12 | Transparent PE tube | Max. 1 bag (8pcs/bag) |  |
| 13 | Round Port accessories bag | 2pc(GP220) |  | 14 | Aluminium foil | 16pc(GP202) |  |
| | | 1pc(GP304) | | | | 6pc(GP304) | |
| 15 | Oval port accessories bag | 1pc |  | 16 | Abrasive tape | 1pc |  |
| 17 | Cleaning tissue | 1pc (Optional) |  | 18 | Shield continuity wire | 1pc (Optional) |  |
| 19 | AMP clamp | 1pc (Optional) |  | 20 | Branch off clip | 1pc (Optional) |  |

FCST012216 Fiber Optical Splice Closure

Design And Customization Services

- Provide service with whole process from blueprint to product to the customer.
- Meet customer's requirement to customize logo in suitable place for existing product.
- Meet customer's requirement to make reasonable modify and customization for existing product.
- Provide free design according to the requirement of customer after signed cooperative agreement.



FCST01131

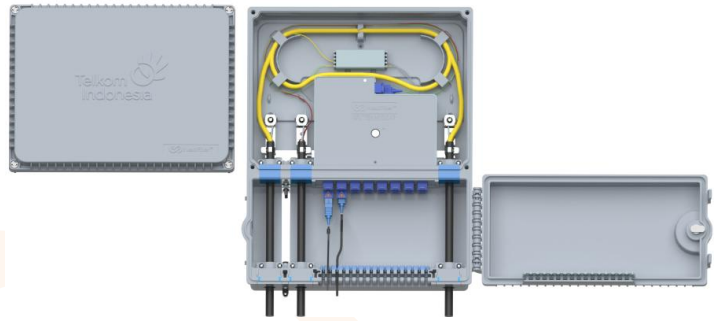

FCST02253